



IT9388-HT

Turret Dome Network Camera

5MP • Remote Focus • SNV • WDR Pro • 30M IR • Smart Stream III • IP66

- H.265 Compression Technology
- 20 fps @ 2560x1920 (WDR Pro on)
- 2.8~12 mm, Remote Focus
- WDR Pro for Unparalleled Visibility in Extremely Bright and Dark Environments
- SNV (Supreme Night Visibility) for Low Light Conditions
- Smart Stream III to Optimize Bandwidth Efficiency
- Built-in IR Illuminators, Effective up to 30 Meters
- Weather-proof IP66-rated and Vandal-proof IK10-rated Housing
- Trend Micro IoT Security
- Built-in MicroSD/SDHC/SDXC Card Slot for On-board Storage
- Built-in Microphone





Technical Specifications

System Information

Model	IT9388-HT
CPU	Multimedia SoC (System-on-Chip)
Flash	128 MB
RAM	512 MB

Camera Features

Image Sensor	1/2.7" Progressive CMOS
Max. Resolution	2560x1920 (5MP)
Lens Type	Motorized, Vari-focal, Remote Focus
Focal Length	f = 2.8 ~ 12 mm
Aperture	F1.4 ~ F2.8
Iris Type	Fixed iris
Field of View	90° ~ 30° (Horizontal) 65° ~ 23° (Vertical) 115° ~ 38° (Diagonal)
Shutter Time	1/5 sec. to 1/32,000 sec.
WDR Technology	WDR Pro
Day/Night	Yes
Removable IR-cut Filter	Yes
IR Illuminators	Built-in IR illuminators, effective up to 30 meters with Smart IR, IR LED*2
Minimum Illumination	0.035 lux @ F1.4 (Color) <0.005 lux @ F1.4 (B/W) 0 lux with IR illumination on
Pan Range	360°
Tilt Range	70°
Rotation Range	360°
Pan/Tilt/Zoom Functionalities	ePTZ: 48x digital zoom (4x on IE plug-in, 12x built-in)
Storage	Seamless Recording to MicroSD/SDHC/SDXC card and recording to network-attached storage (NAS)
Built-in Installation Aids	Remote focus, remote zoom

Video

Video Compression	H.265, H.264, MJPEG
Maximum Frame Rate	20 fps @ 2560x1920
Maximum Streams	3 video streams (Up to 8 configurable profiles)
S/N Ratio	61 dB
Dynamic Range	120 dB
Video Streaming	Adjustable resolution, quality and bit rate control, Smart Stream III
Image Settings	General settings: video title and time stamp overlay, video orientation (flip, mirror, rotation), day/night settings; Illuminators: illuminators, anti-overexposure; Image settings: white balance, image adjustment (brightness, contrast, saturation, sharpness, gamma curve), defog, 3DNR; Exposure: BLC, HLC, exposure control (exposure level, exposure time, gain control), AE speed adjustment, WDR; Privacy mask; Scheduled profile settings

Audio

Audio Capability	One-way Audio
Audio Compression	G.711, G.726
Audio Interface	Built-in microphone
Effective Range	5 meters

Network

Users	Live viewing for up to 10 clients
Security	Access list, digest authentication, HTTPS, IEEE 802.1x, password protection, signed firmware, Trend Micro IoT Security (brute force attack event, cyberattack event, quarantine event), user access log, user account management



Protocols	802.1X, ARP, Bonjour, CIFS/SMB, DDNS, DHCP, DNS, FTP, HTTP, HTTPS, ICMP, IGMPv3, IPv4, IPv6, NTP, PPPoE, QoS (CoS/DSCP), RTSP/RTP/RTCP, SMTP, SNMP, SSL, TCP/IP, TLS 1.2, UDP, UPnP
Interface	10 Base-T/100 Base-TX Ethernet (RJ-45) *It is highly recommended to use standard CAT5e & CAT6 cables which are compliant with the 3P/ETL standard.
ONVIF	Profile G, S, T supported, specification available at www.onvif.org
Solution Integration	
Video Motion Detection	Five-window video motion detection
VADP Package	Stratocast, Trend Micro IoT Security (1-year free trial), VIVOCLOUD
Alarm and Event	
Event Trigger	Audio detection, camera tampering detection, cybersecurity events (brute force attack event, cyberattack event, quarantine event), manual trigger, motion detection, periodical trigger, recording notification, SD card life expectancy, system boot
Event Action	Event notification via email, HTTP, FTP, NAS server, SD card, push notification File upload via email, HTTP, FTP, NAS server, SD card
General	
Connectors	RJ-45 cable connector for 10/100Mbps Network/PoE connection
Power Input	IEEE 802.3af PoE Class 0
Power Consumption	Max. 9.8 W/6.29 W (IR on/off)
Dimensions	Ø 120 x 90.5 mm
Weight	625 g
Certifications	EMC: CE (EN 55032 Class B, EN 55024), FCC (FCC Part 15 Subpart B Class B), RCM (AS/NZS CISPR 32 Class B), VCCI (VCCI-CISPR 32 Class B); Safety: UL (UL 62368-1), CB (IEC/EN 62368-1, IEC/EN 60950-22, IEC/EN 62471); Environment: IK10 (IEC 62262), IP66 (IEC 60529); IA: BIS (IS 13252)
Operating Temperature	Starting Temperature: -10°C ~ 60°C (14°F ~ 140°F) Working Temperature: -30°C ~ 60°C (-22°F ~ 140°F)
Humidity	90%
Warranty	36 months
System Requirements	
Operating System	Microsoft Windows 10/8/7 Mac 10.12 (Chrome only)
Web Browser	Chrome 58.0 or above Internet Explorer 10/11
Other Players	VLC: 1.1.11 or above
Included Accessories	
Packing Contents	Quick installation guide, alignment sticker, screw pack, cable gland



Dimensions

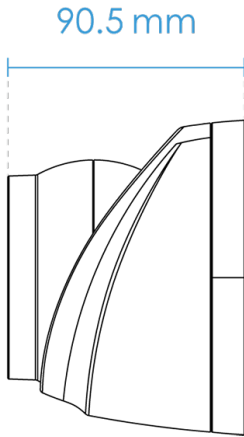
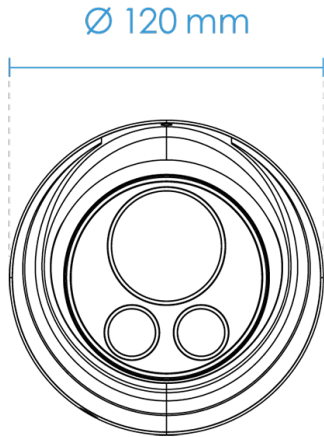

Compatible Accessories

Mounting Kits



AM-21A (V02)
L-shape Bracket

Mounting Kits



AM-51G
Adapting Plate

Mounting Kits



AM-52E
Mounting Adapter

Mounting Kits



AM-71B
Outdoor Conduit Box



All specifications are subject to change without notice. Copyright©VIVOTEK INC. All rights reserved. Ver. 5