

52.603

Viewmate monitor arm - desk 603

This dual monitor arm combines strength, practicality and usability in one package. The crossbar is adjustable in height and depth. The handle bar lets you adjust the depth of your monitors with the greatest of ease. With cable management on the crossbar and pole, this product offers a practical and user-friendly way to achieve a great and affordable dual monitor set-up.

- Depth adjustment by using a handle bar
- Easy to adjust in height using a clamp lever
- Static height adjustment range of 295 mm (11,6")
- Fitted with cable clips and cable loop ties to guide cables tidily
- Main components made of steel
- VESA MIS-D 75 x 75/100 x 100 mm compatible
- Monitor: tilt +90°/-90°, rotate 360°
- Arm: swivel 360°
- Weight capacity max. 7,5 kg (33 lb) per monitor
- Monitor size limit: width 640 mm (25,2") - height 712 mm (28,0")
- Comes with a desk clamp mount and bolt-through desk mount
- Suitable for a desktop thickness of 5 up to 40 mm (0,2" - 1,6") (clamp) or 50 mm (2,0") (bolt through)
- Unique mechanism enables precise horizontal levelling

viewmate ^x

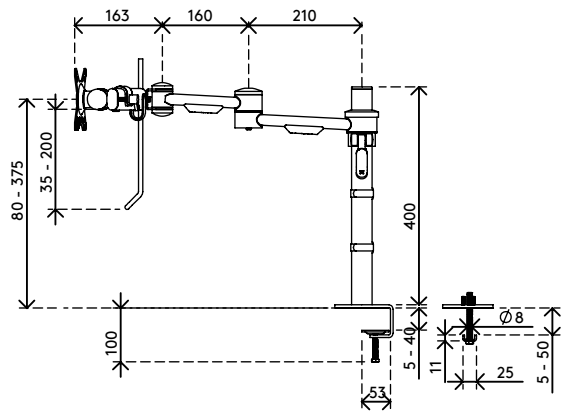
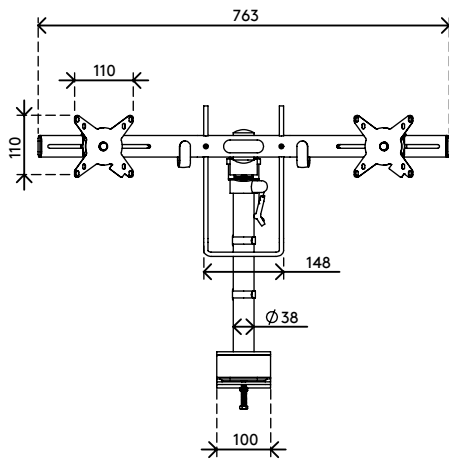
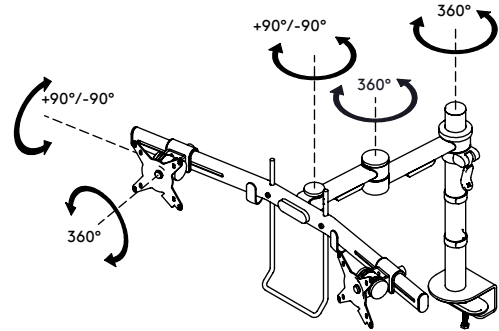
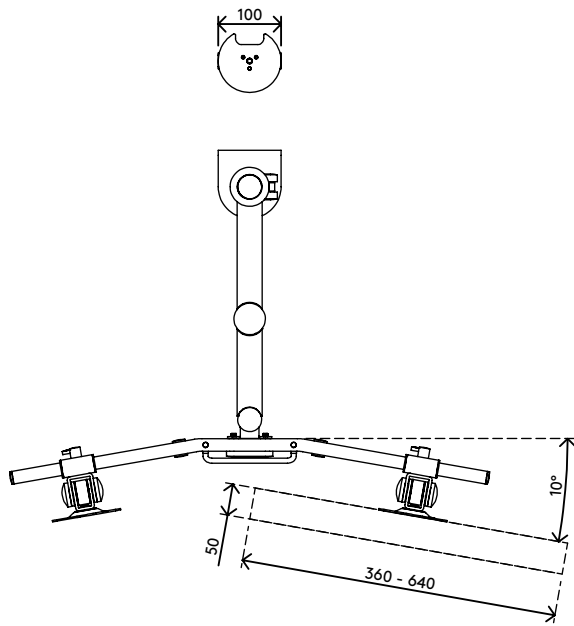

295 mm (11,6")



+90°/-90°



360°



640 mm (25,2")

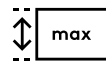

713 mm (28,1")



75 x 75/100 x 100



(2x) 7,5 kg (16,5 lb)

Viewmate monitor arm - desk 603

2020/10/06

52.603

825 x 265 x 150 mm

1 pcs

black

7 kg

805410526030