

## 13"-27" Articulating Dual Monitor Desk Mount Bracket

Model No.: 650152



### I Overview

The equip<sup>®</sup> Dual Monitors Desk Mount Bracket is a compact but sturdy product that ensures a reliable installation of your LCD/LED monitor. Follow the graphic guide included in the package, you can install your monitor on your own with ease.

### I Drawing

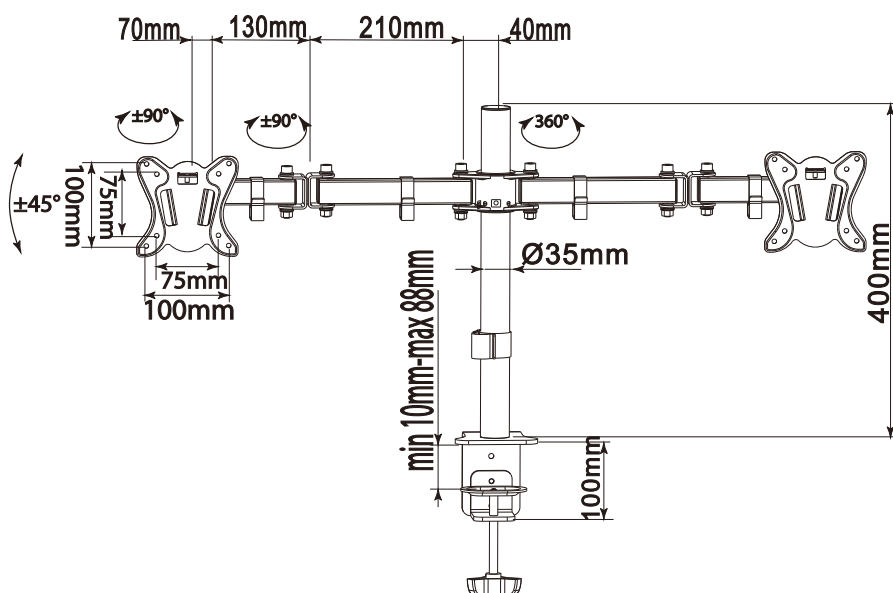

## I Key Features

- 360° Rotary VESA Plate
- Easy to adjust height
- Built in cable management
- VESA standards compliant

## I Specification

<b>Material</b>	Steel, Aluminum, Plastic
<b>Surface Finished</b>	Powder Coating
<b>Color</b>	Black
<b>Dimension</b>	726x550x116mm/900x500x70mm
<b>Installation</b>	Grommet, Clamp
<b>Suggested Screen Size</b>	13" - 27"
<b>Support Curved TV</b>	No
<b>Screen Q'ty</b>	2
<b>Load Capacity</b>	8KG per Monitor
<b>VESA Mount Standard</b>	75x75, 100x100
<b>Tilt Range</b>	+45° ~ -45°
<b>Swivel Range</b>	+90° ~ -90°
<b>Screen Rotation</b>	+180° ~ -180°
<b>Arm Full Extension</b>	428mm/450mm
<b>Pole Height</b>	400mm
<b>Suggest Desktop Thickness</b>	Clamp: Max.88mm, Grommet: Max.75mm
<b>Quick Release VESA Plate</b>	Yes
<b>Anti-Theft</b>	No
<b>Cable Management</b>	Yes

## I Package Contents

- 1 x Dual Monitor Desk Mount Bracket
- 1 x Screw Pack
- 1 x Quick Installation Guide