



2-Port USB 3.0 Fiber Extender

Easily extend SuperSpeed USB 3.0 signals up to 330 feet (100 meters) over fiber.



Contact Information

Order toll-free in the U.S. or for FREE 24/7 technical support: Call 877-877-BBOX (outside U.S. call 724-746-5500)
www.blackbox.com • info@blackbox.com

Trademarks Used in this Manual/FCC and IC RFI Statement

Trademarks Used in this Manual

Black Box and the Double Diamond logo are registered trademarks of BB Technologies, Inc.

Mac OS X is a registered trademark of Apple Computer, Inc.

Intel is a registered trademark of Intel Corporation.

Windows is a registered trademark of Microsoft Corporation.

Linux is a registered trademark of Linus Torvalds.

Any other trademarks mentioned in this manual are acknowledged to be the property of their respective owners.

Federal Communications Commission and Industry Canada Radio Frequency Interference Statements

This equipment generates, uses, and can radiate radio-frequency energy, and if not installed and used properly, that is, in strict accordance with the manufacturer's instructions, may cause interference to radio communication. It has been tested and found to comply with the limits for a Class A computing device in accordance with the specifications in Subpart B of Part 15 of FCC rules, which are designed to provide reasonable protection against such interference when the equipment is operated in a commercial environment. Operation of this equipment in a residential area is likely to cause interference, in which case the user at his own expense will be required to take whatever measures may be necessary to correct the interference.

Changes or modifications not expressly approved by the party responsible for compliance could void the user's authority to operate the equipment.

This digital apparatus does not exceed the Class A limits for radio noise emission from digital apparatus set out in the Radio Interference Regulation of Industry Canada.

Le présent appareil numérique n'émet pas de bruits radioélectriques dépassant les limites applicables aux appareils numériques de la classe A prescrites dans le Règlement sur le brouillage radioélectrique publié par Industrie Canada.

Instrucciones de Seguridad (Normas Oficiales Mexicanas Electrical Safety Statement)

1. Todas las instrucciones de seguridad y operación deberán ser leídas antes de que el aparato eléctrico sea operado.
2. Las instrucciones de seguridad y operación deberán ser guardadas para referencia futura.
3. Todas las advertencias en el aparato eléctrico y en sus instrucciones de operación deben ser respetadas.
4. Todas las instrucciones de operación y uso deben ser seguidas.
5. El aparato eléctrico no deberá ser usado cerca del agua—por ejemplo, cerca de la tina de baño, lavabo, sótano mojado o cerca de una alberca, etc.
6. El aparato eléctrico debe ser usado únicamente con carritos o pedestales que sean recomendados por el fabricante.
7. El aparato eléctrico debe ser montado a la pared o al techo sólo como sea recomendado por el fabricante.
8. Servicio—El usuario no debe intentar dar servicio al equipo eléctrico más allá a lo descrito en las instrucciones de operación. Todo otro servicio deberá ser referido a personal de servicio calificado.
9. El aparato eléctrico debe ser situado de tal manera que su posición no interfiera su uso. La colocación del aparato eléctrico sobre una cama, sofá, alfombra o superficie similar puede bloquea la ventilación, no se debe colocar en libreros o gabinetes que impidan el flujo de aire por los orificios de ventilación.
10. El equipo eléctrico debe ser situado fuera del alcance de fuentes de calor como radiadores, registros de calor, estufas u otros aparatos (incluyendo amplificadores) que producen calor.
11. El aparato eléctrico deberá ser conectado a una fuente de poder sólo del tipo descrito en el instructivo de operación, o como se indique en el aparato.
12. Precaución debe ser tomada de tal manera que la tierra física y la polarización del equipo no sea eliminada.
13. Los cables de la fuente de poder deben ser guiados de tal manera que no sean pisados ni pellizcados por objetos colocados sobre o contra ellos, poniendo particular atención a los contactos y receptáculos donde salen del aparato.
14. El equipo eléctrico debe ser limpiado únicamente de acuerdo a las recomendaciones del fabricante.
15. En caso de existir, una antena externa deberá ser localizada lejos de las líneas de energía.
16. El cable de corriente deberá ser desconectado del cuando el equipo no sea usado por un largo periodo de tiempo.
17. Cuidado debe ser tomado de tal manera que objetos líquidos no sean derramados sobre la cubierta u orificios de ventilación.
18. Servicio por personal calificado deberá ser provisto cuando:
 - A: El cable de poder o el contacto ha sido dañado; u
 - B: Objetos han caído o líquido ha sido derramado dentro del aparato; o
 - C: El aparato ha sido expuesto a la lluvia; o
 - D: El aparato parece no operar normalmente o muestra un cambio en su desempeño; o
 - E: El aparato ha sido tirado o su cubierta ha sido dañada.

Table of Contents

Table of Contents

| | |
|--|----|
| 1. Specifications | 5 |
| 2. Overview | 6 |
| 2.1 Introduction | 6 |
| 2.2 Features..... | 6 |
| 2.3 What's Included | 6 |
| 2.4 Hardware Description..... | 7 |
| 2.4.1 Local Extender Unit..... | 7 |
| 2.4.2 Remote Extender Unit | 8 |
| 2.5 Typical Application | 9 |
| 3. Installation | 10 |
| 3.1 Requirements | 10 |
| 3.2 Fiber Optic Link Cabling | 10 |
| 3.3 Installing the IC502A-R2 System..... | 10 |
| 3.3.1 Preparing Your Site..... | 10 |
| 3.3.2 Preparing Your Computer..... | 10 |
| 3.4 Connecting a USB 3.0 Device..... | 16 |
| 3.5 Installing the Remote Extender..... | 16 |
| 3.6 Installing the Local Extender..... | 16 |
| 3.7 Checking the Installation..... | 17 |
| 3.8 Compatibility | 18 |
| 4. Troubleshooting | 19 |
| 4.1 Problems/Solutions..... | 19 |
| 4.2 Contacting Black Box | 21 |
| 4.3 Shipping and Packaging | 21 |
| Appendix. Technical Glossary..... | 22 |
| A.1 USB Connectors | 22 |
| A.2 Duplex LC Crossover | 22 |

1. Specifications

Table 1-1. Technical Specifications

| | |
|--------------------|--|
| Approvals | EMC: FCC Class B, CE Class B, Machine vision: AIA USB3 Vision, Environmental: RoHS2 (CE) |
| Current | 900 mA available to USB device at remote extender unit for each USB port. |
| Device | Supports USB 3.0 devices with up to 5 Gbps throughput. <i>NOTE: IC502A-R2 is NOT backward compatible with USB 2.0/1.1.</i> |
| Distance | USB 3.0 extension using OM2 multimode fiber: Up to 165 ft. (50 m) for storage or cameras; USB 3.0 extension using OM3 multimode fiber: Up to 165 ft. (50 m) for storage, Up to 330 ft. (100 m) for cameras |
| Enclosure | Anodized aluminum |
| Host | Supports USB host xHCI controllers (Intel®, AMD, Renesas [NEC], Fresco, AsMedia) |
| Connectors | Local Extender Unit: (1) USB 3.0 Type B locking receptacle, (1) duplex LC; Remote Extender Unit: (1) duplex LC, (2) USB 3.0 Type A locking receptacles |
| Temperature | Operating: 32 to 104° F (0 to 40° C); Storage: -4 to +158° F (-20 to +70° C) |
| Humidity | Operating: 20 to 80%, noncondensing; Storage: 10 to 90%, noncondensing |
| Power | Input: 100-/240-VAC, 50–60 Hz, 600 mA maximum; Output: 24 VDC, locking; AC adapter connector: 2.1-mm center-positive jack |
| Dimensions | Each unit (local or remote): 1.02"H x 3.94"W x 2.99"D (2.59 x 10.00 x 7.59 cm) |

2. Overview

2.1 Introduction

Extend USB signals as far as 330 feet (100 meters) to two remote USB 3.0 devices using secure, interference-free fiber cabling.

The 2-Port USB 3.0 Fiber Extender uses multimode fiber optic cabling to extend device signals to remote areas of your factory, office, or security monitoring application.

Compatible with the USB 3.0 or "SuperSpeed USB" standard, the extender boasts speeds up to 5 Gbps, about ten times that of USB 2.0. This way, you can extend your USB bus connections to newer USB 3.0 devices that use higher bandwidths and require bidirectional asynchronous, full-duplex data transfer. Plus, it supplies more power than USB 2.0 to the remote devices.

With the higher data-transfer rate and power, the extender is ideal for connecting industrial USB 3.0 machine vision cameras, particularly those with high power sensors. It's also great for post-production video editing and broadcast applications with USB 3.0 peripherals and external USB CD/DVDs.

The extender offers reliable operation with all USB 3.0 devices, including USB hubs. The local unit draws its power from the USB bus and the two-port remote unit receives its power from the included AC adapter.

NOTE: The IC502A-R2 supports only USB 3.0 devices. USB 2.0 and 1.1 will not function through this extender. IC502A-R2 is NOT backward compatible with USB 2.0/1.1.

2.2 Features

- Ideal for linking to USB 3.0 security and industrial cameras, external DVD drives, and other high-bandwidth USB devices.
- Extends USB 3.0 signals up 330 feet (100 m) over multimode fiber cable.
- Transfers at 5-Gbps speeds—ten times faster than USB 2.0.

2.3 What's Included

Your package should include the following items. If anything is missing or damaged, contact Black Box Technical Support at 724-746-5500 or info@blackbox.com.

- (1) Local Extender Unit
- (1) Remote Extender Unit
- (1) Remote Extender AC power adapter
- (1) USB 3.0 cable
- (1) U.S. power cable
- Quick start guide

To download this user manual, visit the Black Box Web site (www.blackbox.com) and enter **IC502A-R2** in the search bar.

1. Go to www.blackbox.com
2. Enter the part number (IC502A-R2) in the search box.
3. Click on the product in the "Product Results" page.
4. Click on the "Support" tab on the product page, and select the document you wish to download.

If you have any trouble accessing the Black Box site to download the manual, you can contact our Technical Support at 877-877-2269 or info@blackbox.com.

2.4 Hardware Description

Figures 2-1 and 2-2 show the front and back panels of the Local Extender Unit. Table 2-1 describes the local extender components. Figures 2-3 and 2-4 show the front and back panels of the Remote Extender Unit. Table 2-2 describes the remote extender components.

2.4.1 Local Extender

The local extender connects to the host computer using the supplied USB 3.0 A-B cable.

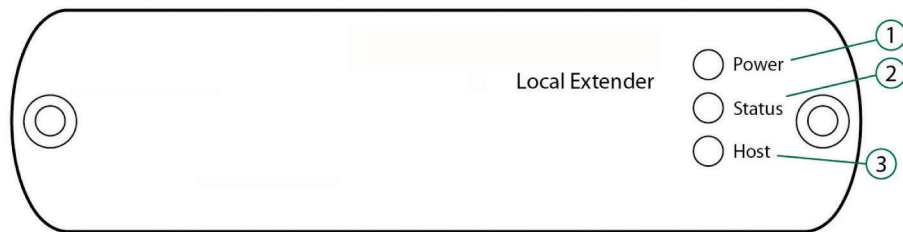

Figure 2-1. Front panel of the local extender.

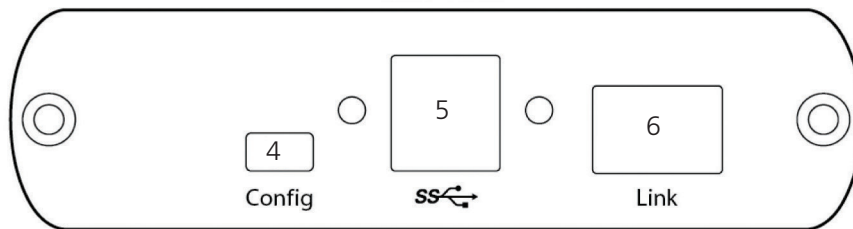

Figure 2-2. Back panel of the local extender.

Table 2-1. Local Extender components.

| Item | Component | Description |
|------|-----------------------|---|
| 1 | Power LED | ON when the unit is powered properly. OFF when the unit is not powered or not powered properly. |
| 2 | Status LED | Blinking (1 Hz) when the local extender is waiting for a connection to the remote extender. ON when local and remote extenders are linked and operating normally. OFF when a fault is detected; power cycle required. |
| 3 | Host LED | ON when a SuperSpeed Host is detected on the upstream port. OFF when a SuperSpeed Host is not detected. |
| 4 | Config Port | Reserved for manufacturer use. |
| 5 | USB 3.0 Type B port | Used to connect the local extender to the host computer. Port accepts locking or non-locking USB 3.0 Type B connectors. |
| 6 | Link Port (Duplex LC) | Extension link duplex LC fiber optic transceiver port. |

2.4.2 Remote Extender

The remote extender provides two downstream Type A ports to connect up to two USB 3.0 devices directly. The remote extender is powered by an external AC adapter and can supply up to 900 mA to each USB port.

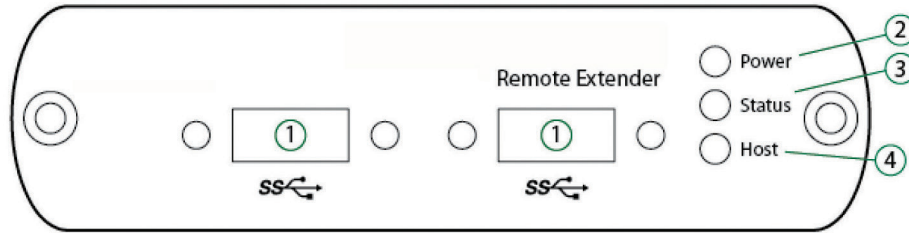

Figure 2-3. Front panel of the remote extender.

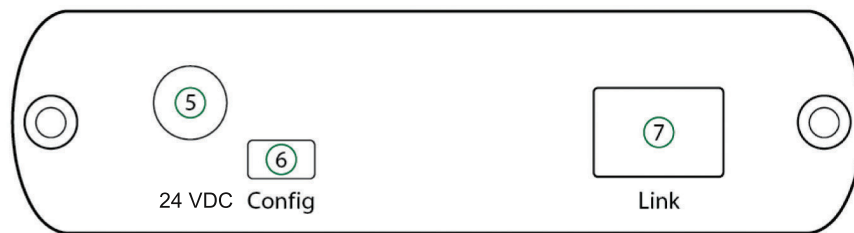

Figure 2-4. Back panel of the remote extender.

Table 2-2. Remote Extender components.

| Item | Component | Description |
|------|--------------------------|---|
| 1 | (2) USB 3.0 Type A ports | Used to connect USB 3.0 device(s) to the remote extender. Port accepts locking or non-locking USB 3.0 Type A connectors. |
| 2 | Power LED | ON when the unit is powered properly. OFF when the unit is not powered or not powered properly. |
| 3 | Status LED | Blinking (1 Hz) when the remote extender is waiting for a connection to the local extender. ON when local and remote extenders are linked and operating normally. OFF when a fault is detected; power cycle required. |
| 4 | Host LED | ON when a SuperSpeed Host is detected on the upstream port. OFF when a SuperSpeed Host is not detected. |
| 5 | Power Port (optional) | Connects to the locking AC power supply. Required on remote extender for proper operation. Output is 24 VDC. |
| 6 | Config Port | Reserved for manufacturer use. |
| 7 | Link Port (Duplex LC) | Extension link Duplex LC fiber optic transceiver port. |

2.5 Typical Application

Figure 2-5 shows a typical installation of the extender.

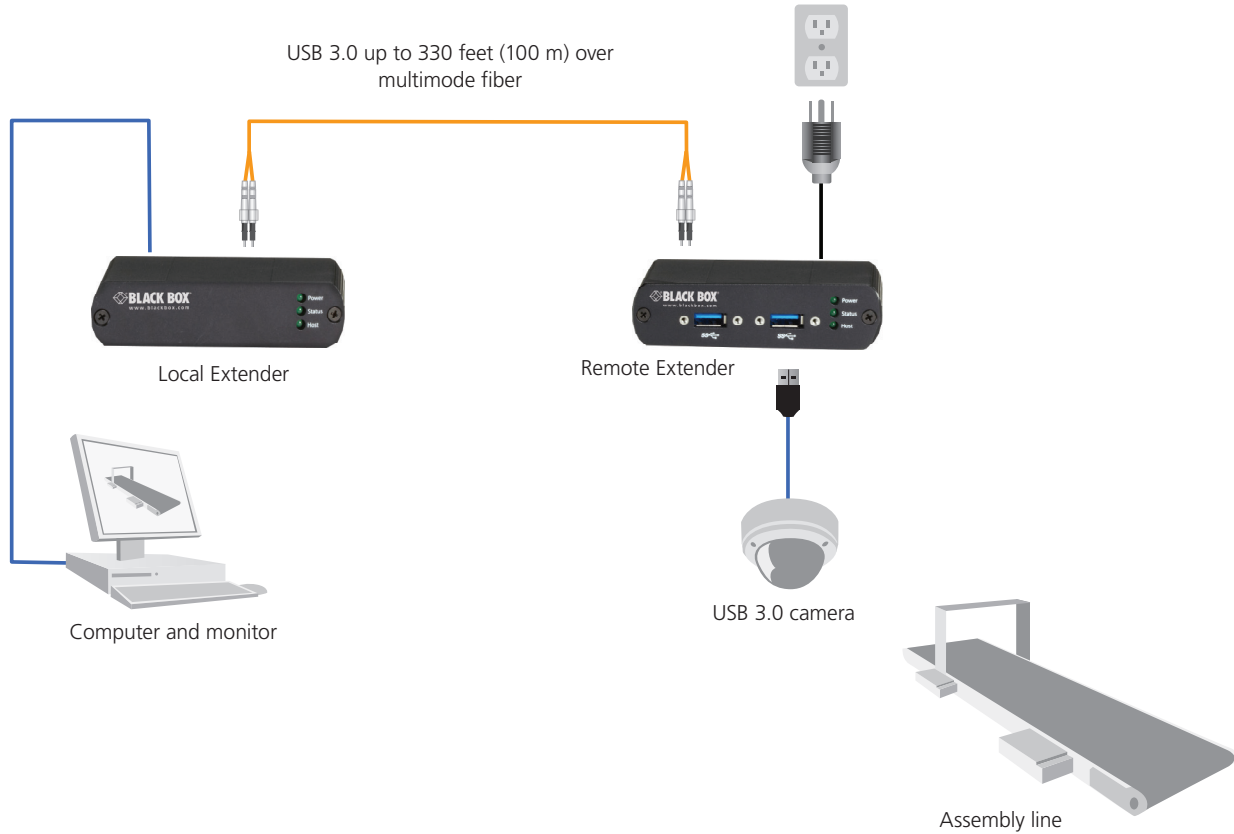

Figure 2-5. Sample installation.

NOTE: The power supply is required to be connected at the remote location.

Chapter 3: Installation

3. Installation

3.1 Requirements

To complete installation of the IC502A-R2, you will also require the following items that are not included with the product:

- USB 3.0 compatible computer (host computer) with a USB 3.0 compliant operating system.
- USB 3.0 compatible device.
- Two-strand 50-/125- μ m multimode fiber (MMF) optic cable with duplex LC connectors.

NOTE: The maximum length of the multimode fiber (MMF) optic cable supported by the IC502A-R2 system, including patch cords, is 330 feet (100 m) for USB 3.0 cameras, and 165 ft. (50 m) for other devices.

3.2 Fiber Optic Link Cabling

The Local Extender and Remote Extender are interconnected by fiber optic cabling. This cabling must be:

- 50-/125- μ m multimode fiber (MMF).
- Terminated with Duplex LC connectors.

The extender can achieve the following maximum distances, depending on the application and cabling standard:

- Using OM3, reach up to 330 feet (100 m) with USB 3.0 cameras, and up to 165 feet (50 m) for all other applications.
- Using OM2, reach up to 165 feet (50 m) for all applications.

NOTE: For help sourcing appropriate fiber optic cabling, contact Black Box Technical Support at 724-746-5500 or info@blackbox.com.

If premise cabling will be used for the installation, then the distances provided above must be met when measuring from Local Extender to Remote Extender, including the premise cabling and the patch cables. All cables must meet the ratings specified. Patch cables must be terminated with Duplex LC connectors.

3.3 Installing the IC502A-R2 System

3.3.1 Preparing Your Site

Before you can install the IC502A-R2, you need to prepare your site:

1. Determine where the computer will be located and set up the computer.
2. Determine where you want to locate the USB device(s).
3. Make sure fiber optic cabling is in place, prepared, properly terminated, and within the maximum distances as defined for the cabling standard used.

3.3.2 Preparing Your Computer

The IC502A-R2 does not support suspend modes of operation. Your computer should NOT be configured to go into "suspend mode" or to "suspend" the USB ports.

To perform the changes:

Windows (7/8)

To disable "suspend" settings on your computer:

1. Open Control Panel. Open Power Options.

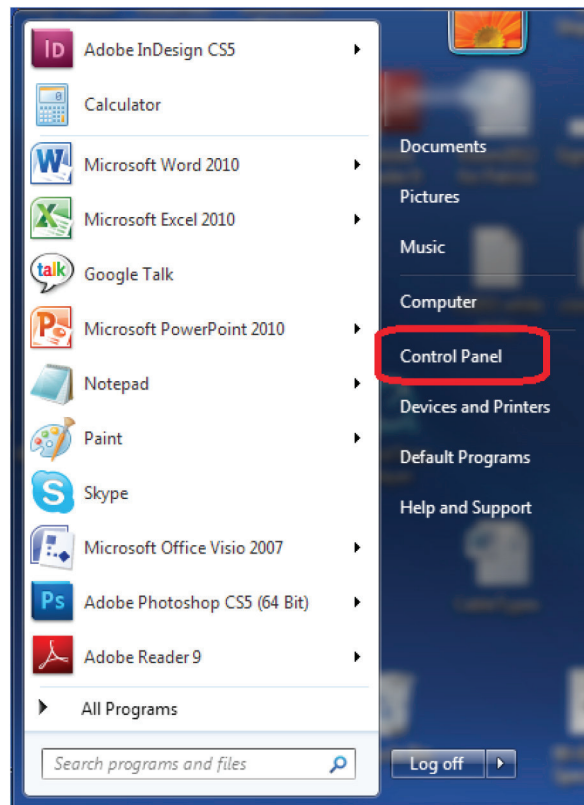

Figure 3-1. Control panel screen.

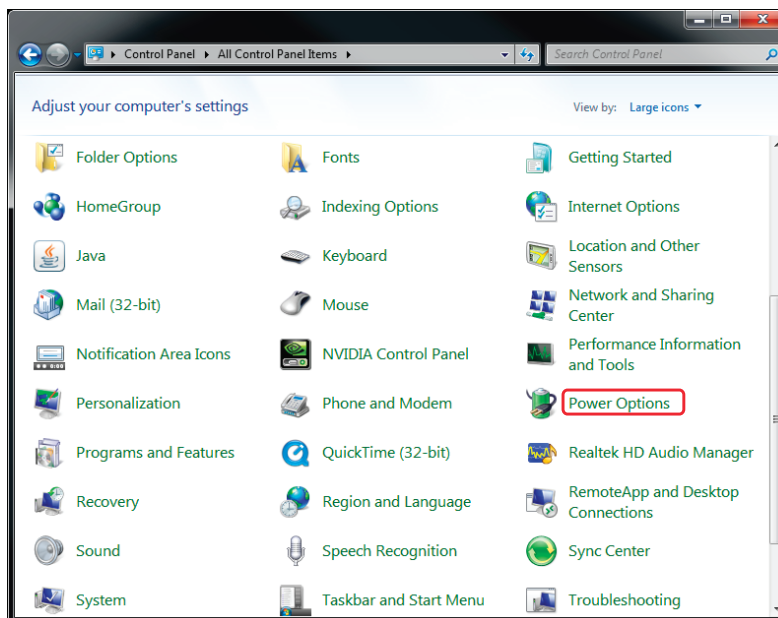

Figure 3-2. Power options selected.

For each of the plans listed:

- a. Click on Change Plan Settings.

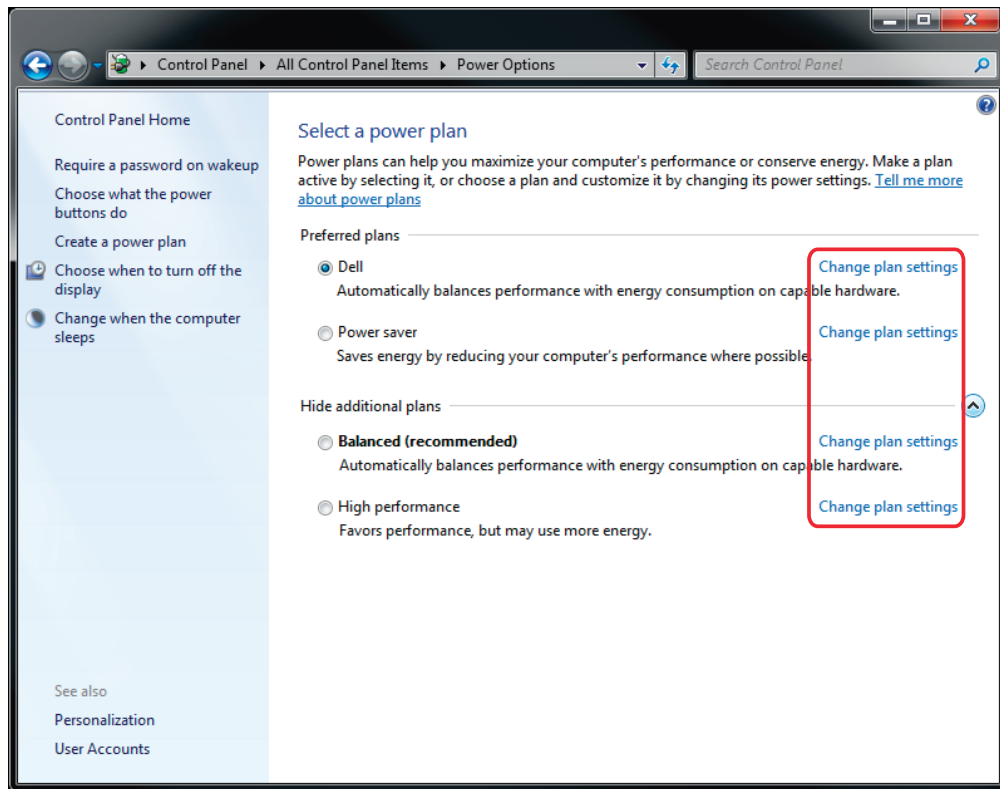

Figure 3-3. Change settings screen.

2. Select "Never" for "Put the computer to sleep" for all the configurations presented.
 - a. Click "Change advanced power settings."

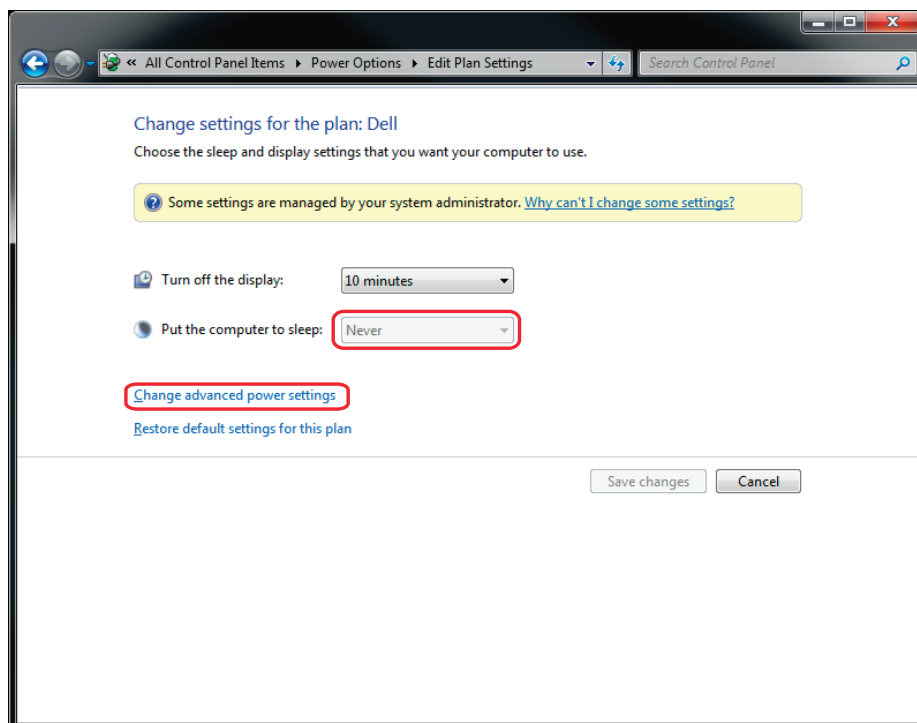

Figure 3-4. Change advanced power settings screen.

- b. Expand "USB settings."
- c. Expand "USB selective suspend setting."
3. Select "Disabled."

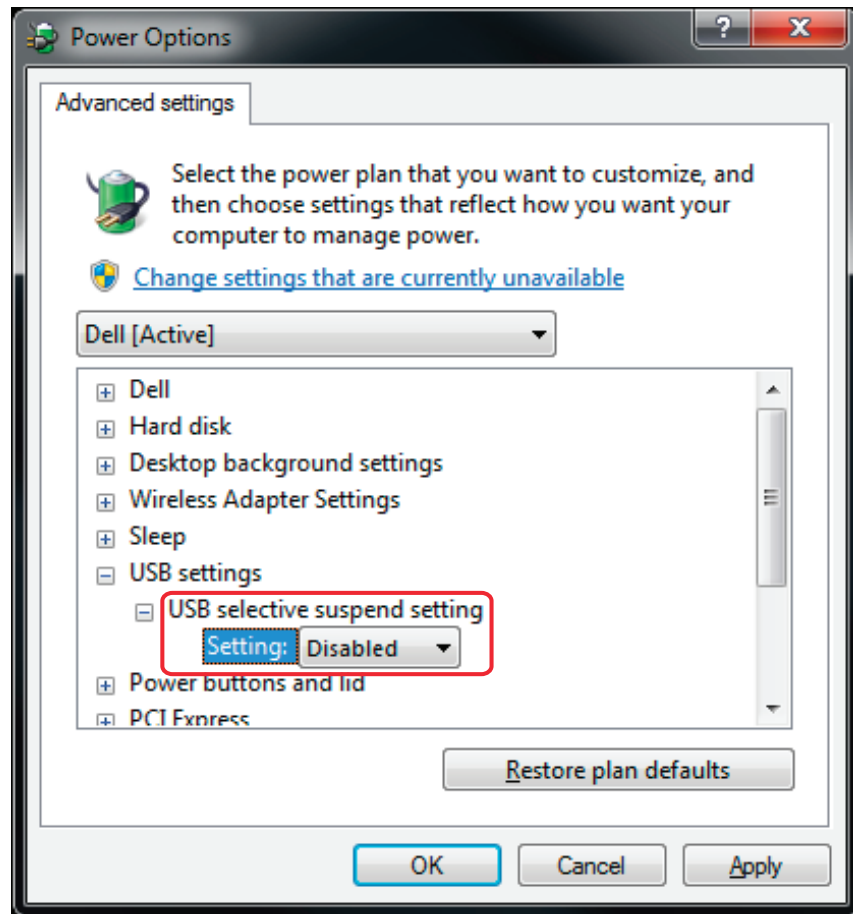

Figure 3-5. USB selective suspend setting.

Chapter 3: Installation

OS X

To disable “suspend” settings on your computer:

1. Open “System Preferences,” and select “Energy Saver.”

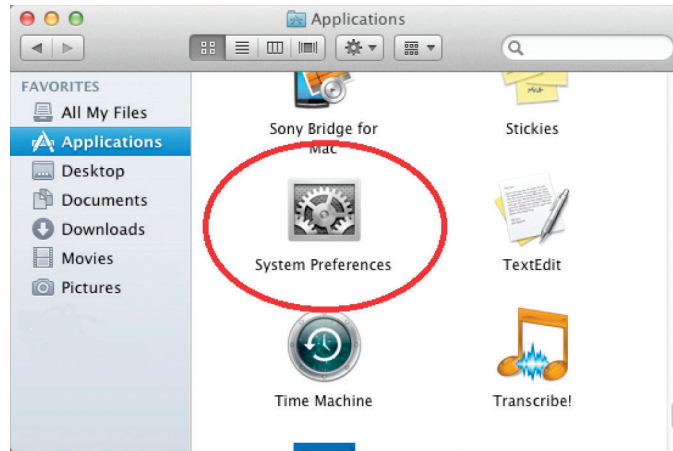

Figure 3-6. System Preferences icon.



Figure 3-7. System Preferences screen, Energy Saver selected.

2. For both Battery and Power Adapter power settings, move slider bar to “Never” for “Computer Sleep.”

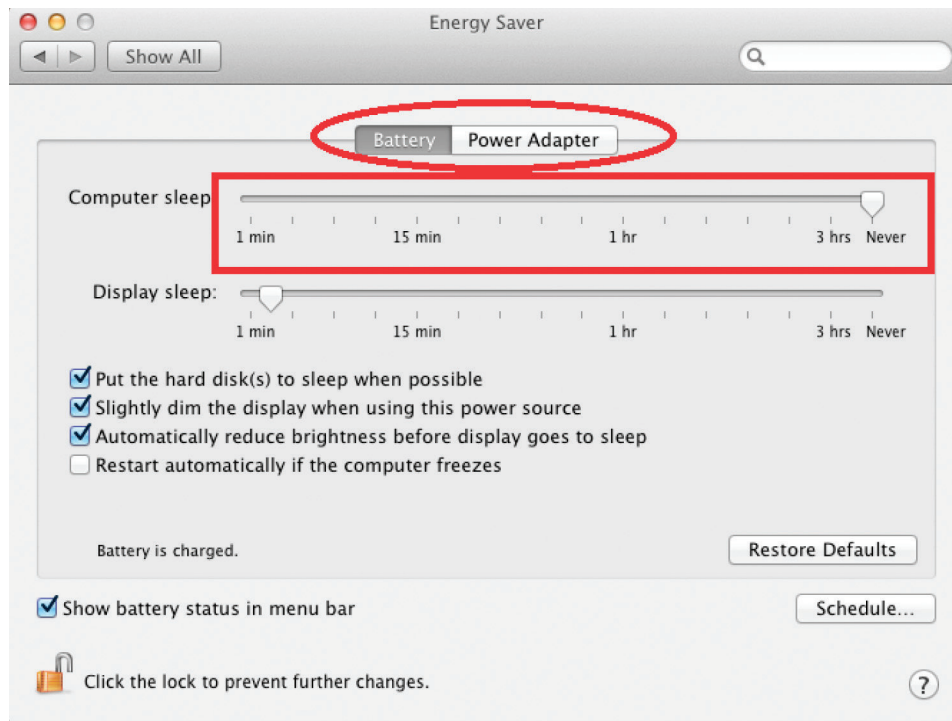

Figure 3-8. Battery and power adapter settings.

3. In the popup warning window, click “OK.”

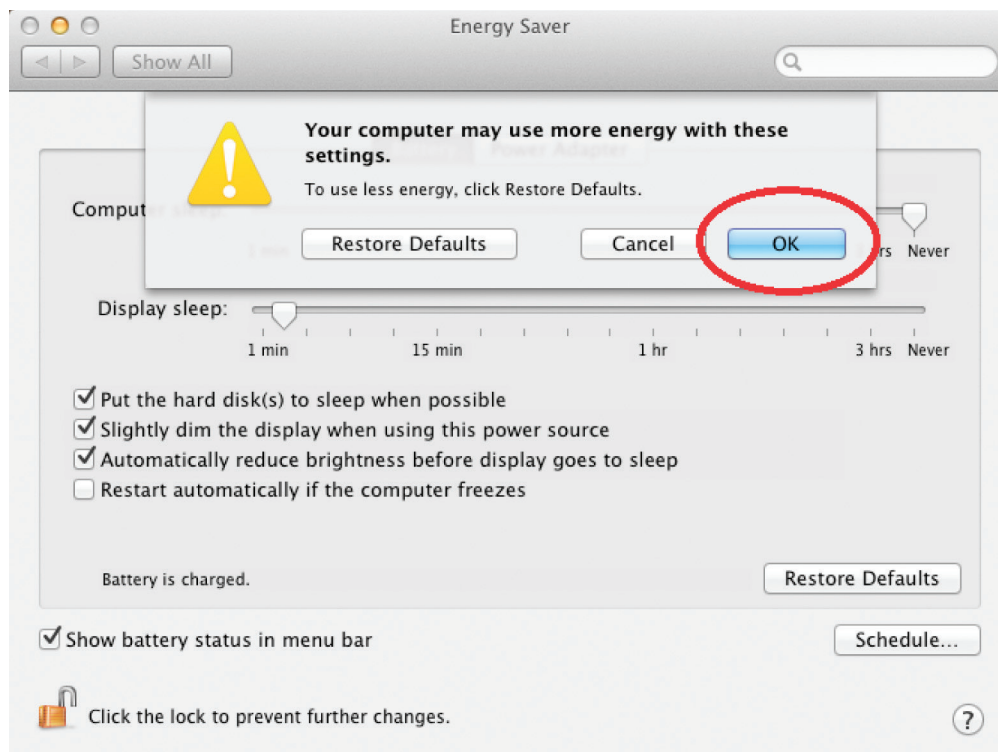

Figure 3-9. Popup warning window.

Chapter 3: Installation

3.4 Connecting a USB 3.0 Device

1. Install any software required to operate the USB device(s). Refer to the documentation for the USB device(s).
2. Connect the USB device to the device port on the Remote Extender. If you are using a USB3 Vision compliant locking USB cable, then you can use the locking knobs to lock the cable to the port on the Remote Extender.

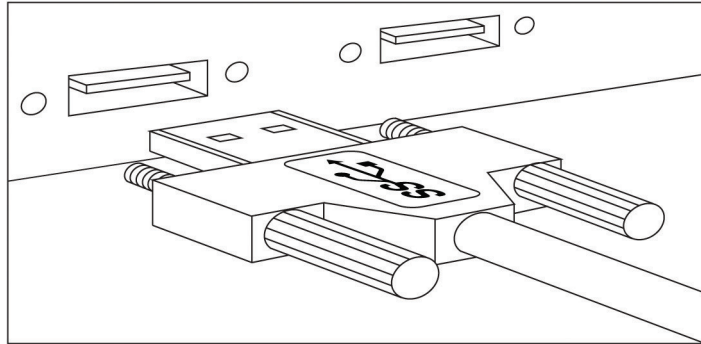

Figure 3-10. USB device connection.

3. Check that the device is detected and installed properly in the operating system.

3.5 Installing the Remote Extender

1. Place the Remote Extender near the USB device(s).
2. Plug the power adapter into a suitable AC outlet.
3. Connect the power adapter to the Remote Extender and twist the connector to lock the power connector into the Remote Extender.

3.6 Installing the Local Extender

1. Place the Local Extender near the computer.
2. Connect the link cable to the Local Extender and the Remote Extender.

With surface cabling:

- Plug one end of the fiber optic cabling (not included) into the Link port on the Local Extender.
- Plug the other end of the fiber optic cabling into the Link port on the Remote Extender.

With premise cabling:

- Plug one end of a fiber optic patch cord (not included) into the Link port on the Local Extender.
- Plug the other end of the patch cord into the fiber optic information outlet near the host computer.
- Plug one end of the 2nd fiber optic patch cord (not included) into the Link port on the Remote Extender.
- Plug the other end of the 2nd patch cord into the fiber optic information outlet near the USB device.

3. Install the supplied USB 3.0 cable between the Local Extender and a USB 3.0 port on the host computer.

CAUTION: The IC502A-R2 will not operate on a USB 2.0 port; make sure you connect to a USB 3.0 port. The USB 3.0 port will have a blue connector inside, whereas a USB 2.0 port will typically have a black connector inside.

3.7 Checking the Installation

1. On the Local and Remote Extenders, check that the Power, Status, and Host LEDs are on and solid. If the Host or Status LEDs are permanently off, then the cabling between the Local and Remote Extender may not be installed properly or is defective.
2. For Windows® users, open “Device Manager” to confirm that the IC502A-R2 has installed correctly. Expand the entry for Universal Serial Bus controllers by clicking the + sign. If the IC502A-R2 has been installed correctly, you should find it listed as two “Superspeed Hubs,” or “3.0 Hubs.”

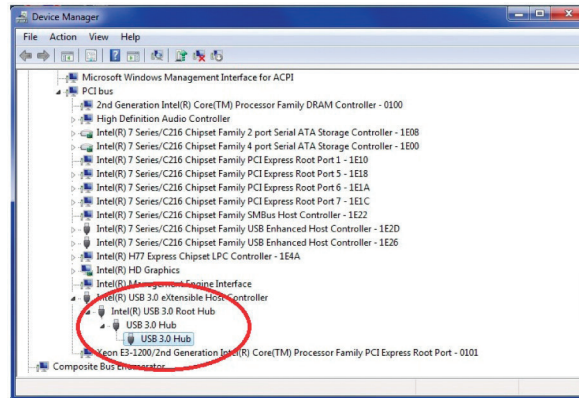

Figure 3-11. Hubs listed screen, Windows operating system.

3. For Mac OS X® users, open the System Profiler to confirm that the IC502A-R2 has installed correctly. In the left hand column under Hardware, select “USB” and inspect the right-hand panel. If the IC502A-R2 has been installed correctly, you should find it listed as a “Hub” under the USB SuperSpeed Bus.

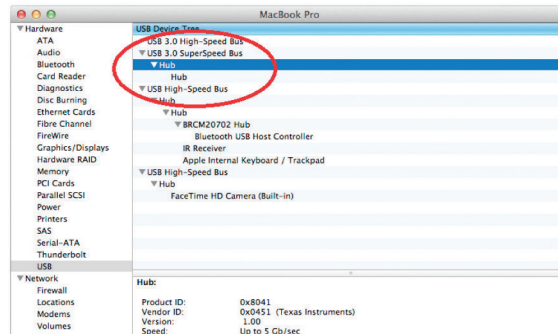

Figure 3-12. Hubs listed screen, Mac operating system.

4. If the IC502A-R2 is not detected correctly or fails to detect, please consult the “Troubleshooting” section in this guide.

NOTE: To open System Profiler in OS X: Open the Finder, select “Applications,” then open the “Utilities” folder and double-click on the “System Profiler” icon.

NOTE: To open Device Manager in Windows 8 or Windows 7: Open the “Start” menu, right-click on “Computer,” then select “Manage >> Device Manager.”

3.8 Compatibility

The IC502A-R2 complies with the USB 3.0 specification. However, Black Box Corporation does not guarantee that all USB 3.0 devices are compatible with the IC502A-R2, because there are a number of different configurations that may impact the operation of USB 3.0 devices over extended distances.

CAUTION: The IC502A-R2 supports only USB 3.0 devices. USB 2.0 and 1.1 devices will not function through this extender.

4. Troubleshooting

4.1 Troubleshooting Tips

The following section provides troubleshooting tips. The topics are arranged in the order in which they should be executed, in most situations. If you are unable to resolve the problem after following these instructions, contact Black Box Technical Support at 724-746-5500 or info@blackbox.com for further assistance.

Problem: All LEDs on the Local Extender are off.

Cause: The Local Extender is not receiving power from the USB port.

Solution(s):

1. Make sure that the USB connection between the Local Extender and host computer is properly installed.
2. Move the USB connector to another USB port on the host computer.

Problem: All LEDs on the Remote Extender are off.

Cause: The Remote Extender is not receiving power from the AC adapter.

Solution(s):

1. Make sure that the AC power adapter is properly connected to the Remote Extender.
2. Check that the AC adapter is connected to a live source of electrical power.

Problem: Status LEDs on both the Local and Remote Extenders are blinking.

Cause(s):

1. There is no connection between the Local Extender and Remote Extender.
2. The Local Extender is not connected to a USB 3.0 port.
3. The host computer does not support USB 3.0.

Solution(s):

1. Make sure that the host computer supports USB 3.0; refer to manual for the computer to confirm.
2. Make sure the Local Extender is connected to a USB 3.0 port. The center of the port should be blue. Another color, such as black, usually indicates a USB 2.0 port.
3. Make sure that a multimode fiber optic cable with crossover is connected between the Local and Remote Extenders.
4. Connect a fiber optic crossover patch cord between the Local and Remote Extenders. Recheck operation of the system.

Chapter 4: Troubleshooting

Problem: Status LED is off on one or both units.

Cause(s):

1. The computer went into suspend, hibernate, or sleep mode.
2. The computer tried to suspend the USB 3.0 port that the Local Extender is connected to.

Solution(s):

1. Power cycle the Remote Extender and the devices connected to the Remote Extender.
2. Power cycle the Local and Remote Extenders, and the devices connected to the REX.
3. Follow the steps in "Preparing Your Computer" in Section 3.3.2 to disable suspend modes on your computer. Refer to your operating system's manual for additional instructions if necessary.

Problem: Host LED on Local/ Remote Extenders is off.

Cause(s):

1. The host computer is not powered on.
2. The Local Extender is not connected to the computer (when used with the optional Local Extender AC adapter).
3. The IC502A-R2 is malfunctioning.

Solution(s):

1. Disconnect all USB devices from the Remote Extender.
2. Disconnect the Local Extender from the computer.
3. Disconnect the Remote Extender from the AC power adapter.
4. Reconnect the Local Extender to the computer.
5. Reconnect the Remote Extender to the AC power adapter.
6. In the Universal Serial Bus controllers section of Device Manager, check that the IC502A-R2 is recognized as two "Superspeed Hubs" or two "3.0 Hubs."

NOTE: It may be recognized as "Superspeed Hub," "3.0 Hub," or by other names, depending on the operating system and driver installed.

Problem: All LEDs on both the Local and Remote Extenders are on, but the USB device does not operate correctly or is detected as an “Unknown Device” in the operating system.

Cause(s):

1. The USB device is malfunctioning.
2. The computer does not recognize the USB device.
3. The application software for the device is not operating.
4. The IC502A-R2 is malfunctioning.

Solution(s):

1. Disconnect the IC502A-R2 from the computer.
2. Connect the USB device directly to the USB port on the computer.
3. If the USB device does not operate properly, consult the user documentation for the device.
4. Update your system BIOS, chipset, or USB Host controller drivers from your System/Motherboard manufacturer’s website.
5. If the USB device operates properly when directly connected to the computer, connect another device (of a different type) to the IC502A-R2. Connect the IC502A-R2 to the computer.
6. If the second USB device does not operate, the IC502A-R2 may be malfunctioning. Contact Black Box Technical Support at 724-746-5500 or info@blackbox.com for assistance.
7. If the second USB device does operate properly, the first device may not be compatible with the IC502A-R2.

4.2 Contacting Black Box

If you determine that your 2-Port USB 3.0 Fiber Extender is malfunctioning, do not attempt to alter or repair the unit. It contains no user-serviceable parts. Contact Black Box Technical Support at 724-746-5500 or info@blackbox.com.

Before you do, make a record of the history of the problem. We will be able to provide more efficient and accurate assistance if you have a complete description, including:

- the nature and duration of the problem.
- when the problem occurs.
- the components involved in the problem.
- any particular application that, when used, appears to create the problem or make it worse.

4.3 Shipping and Packaging

If you need to transport or ship your 2-Port USB 3.0 Fiber Extender:

- Package it carefully. We recommend that you use the original container.
- If you are returning the unit, make sure you include everything you received with it. Before you ship for return or repair, contact Black Box to get a Return Authorization (RA) number.

Appendix. Technical Glossary

A.1 USB Connectors

USB cables have two classes of connectors. The Type A connectors are used to connect the cable from a USB device to a Type A port on a computer or hub. The Type B connectors are used to attach the USB cable from a USB host to a USB device or hub. There are full-sized, mini, and micro variants of both type A and B connectors.

USB 3.0 introduces changes to the connectors. USB 3.0 and USB 2.0 Type A connectors are the same shape and size and are compatible with each other. However, the USB 3.0 Type B connector will not fit in a USB 2.0 Type B port, though a USB 2.0 Type B connector will fit into a USB 3.0 Type B port.

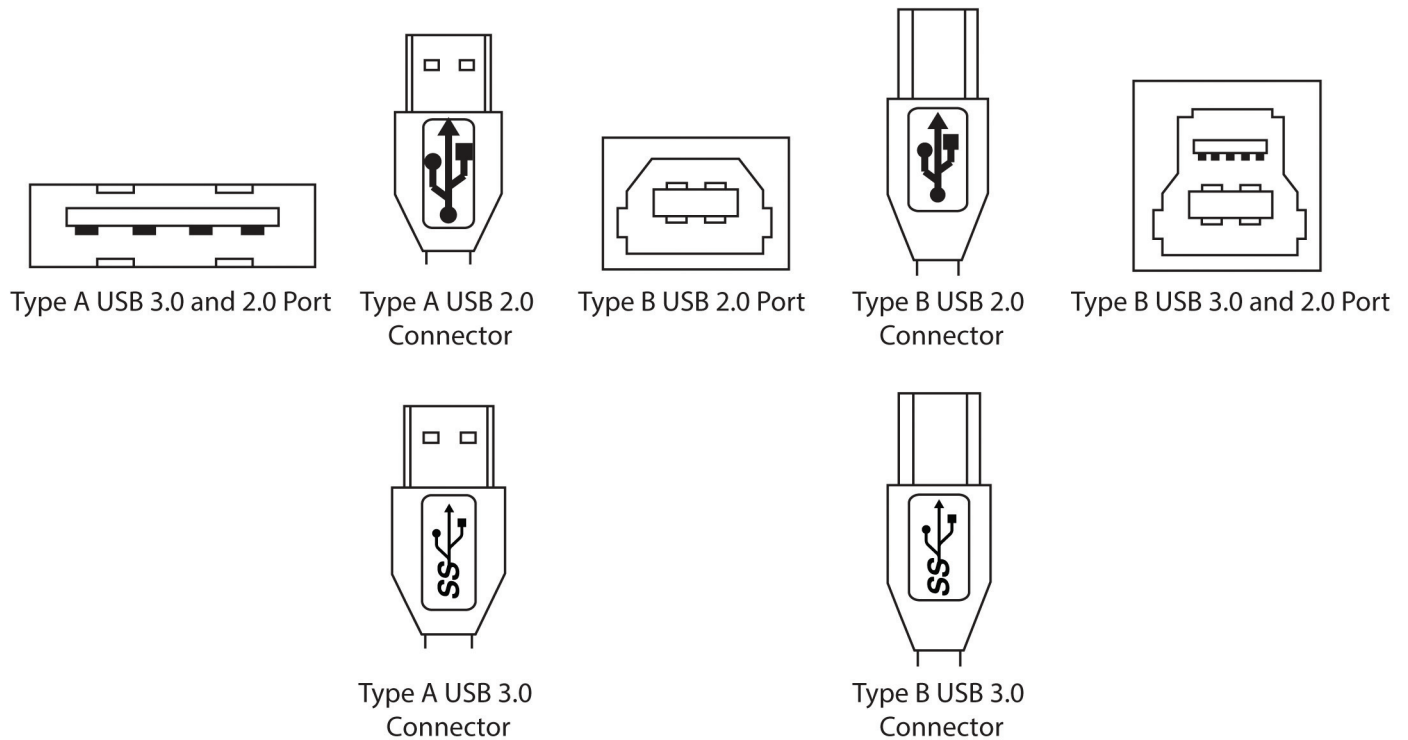

Figure A-1. USB connectors.

A.2 Duplex LC Crossover

When a crossover fiber-optic cable is needed, the cable has the transmit signal on one end connected to the receive signal at the other end.

Black Box Tech Support: FREE! Live. 24/7.

Tech support the
way it should be.



Great tech support is just 60 seconds away at 877-877-2269 or blackbox.com.



About Black Box

Black Box provides an extensive range of networking and infrastructure products. You'll find everything from cabinets and racks and power and surge protection products to media converters and Ethernet switches all supported by free, live 24/7 Tech support available in 60 seconds or less.

© Copyright 2016. Black Box Corporation. All rights reserved.